

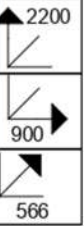

BETTY 02  
 BE02-003-z0



27000,00		22300,00			70018,04		34197,01		30081,00		22243,00		21102,00		32307,02		
A	18x	B	29x	C	24x	D	2x	E	1x	F	5x	G	22x	H	25x	J	2x
36002,07		36002,07			34197,01		35101,01		22246,00		22065,00		30201,00		34197,01		
K	8x	L	8x	M	1x	N	1x	P	16x	R	2x	S	4x	T	4x	U	1x

1h 30min  
 HEX 4  
 PHX 2  
 ≤ 0,5 kg  
 3m  
  
 0,6m



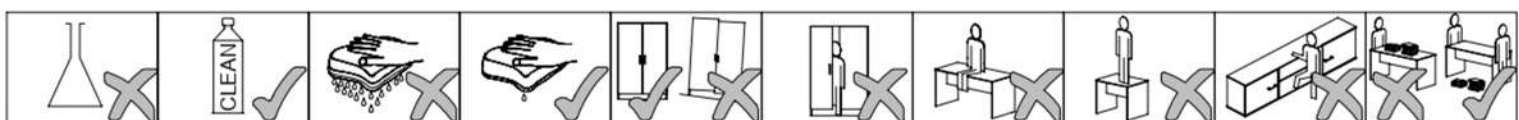
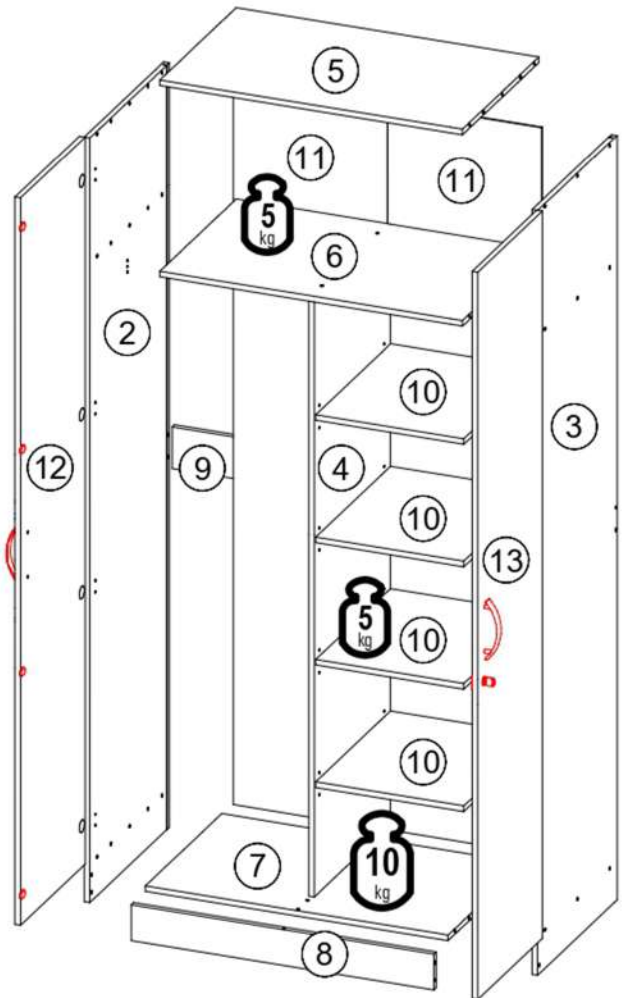
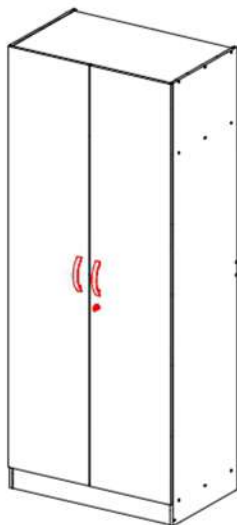

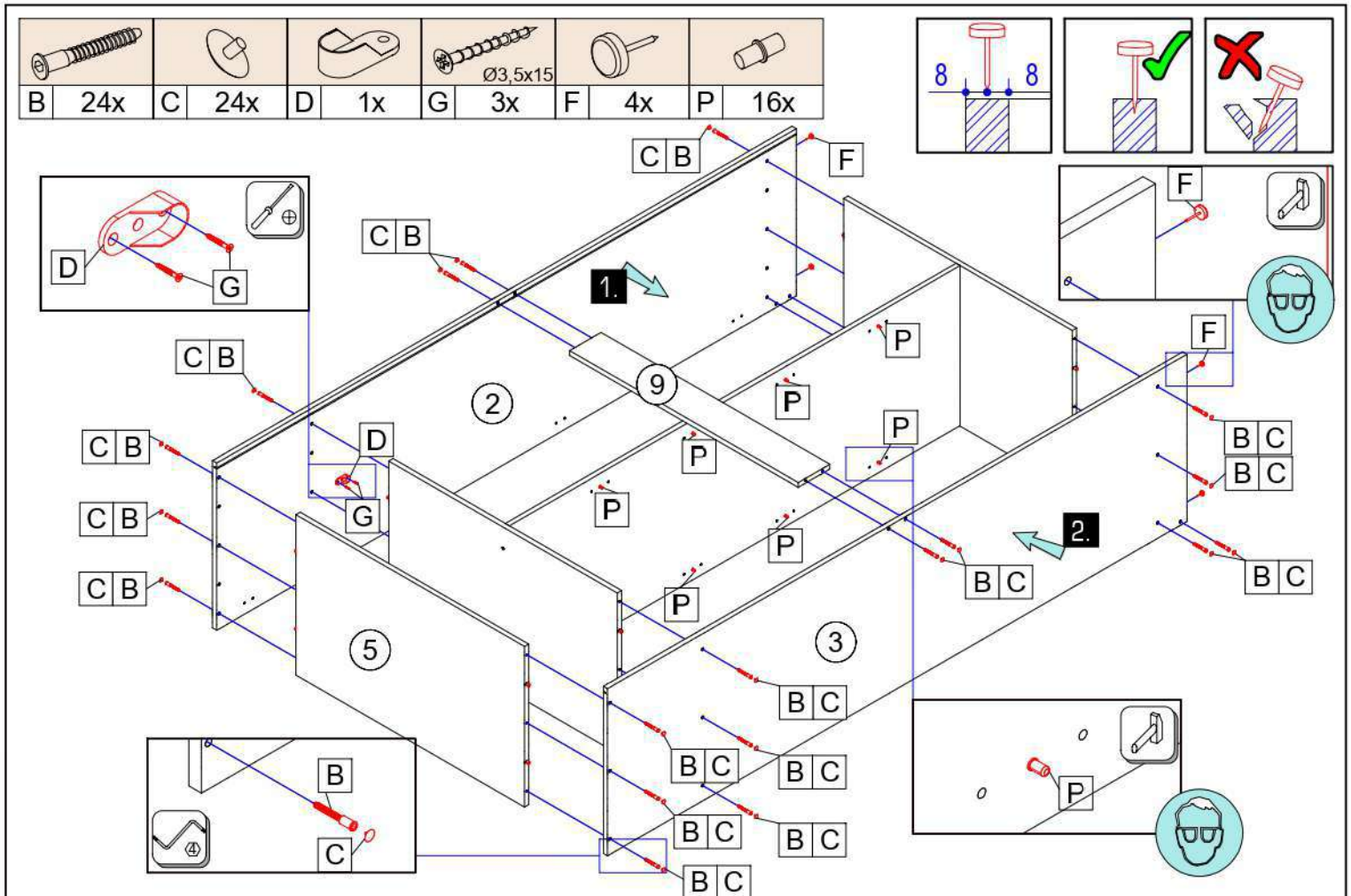
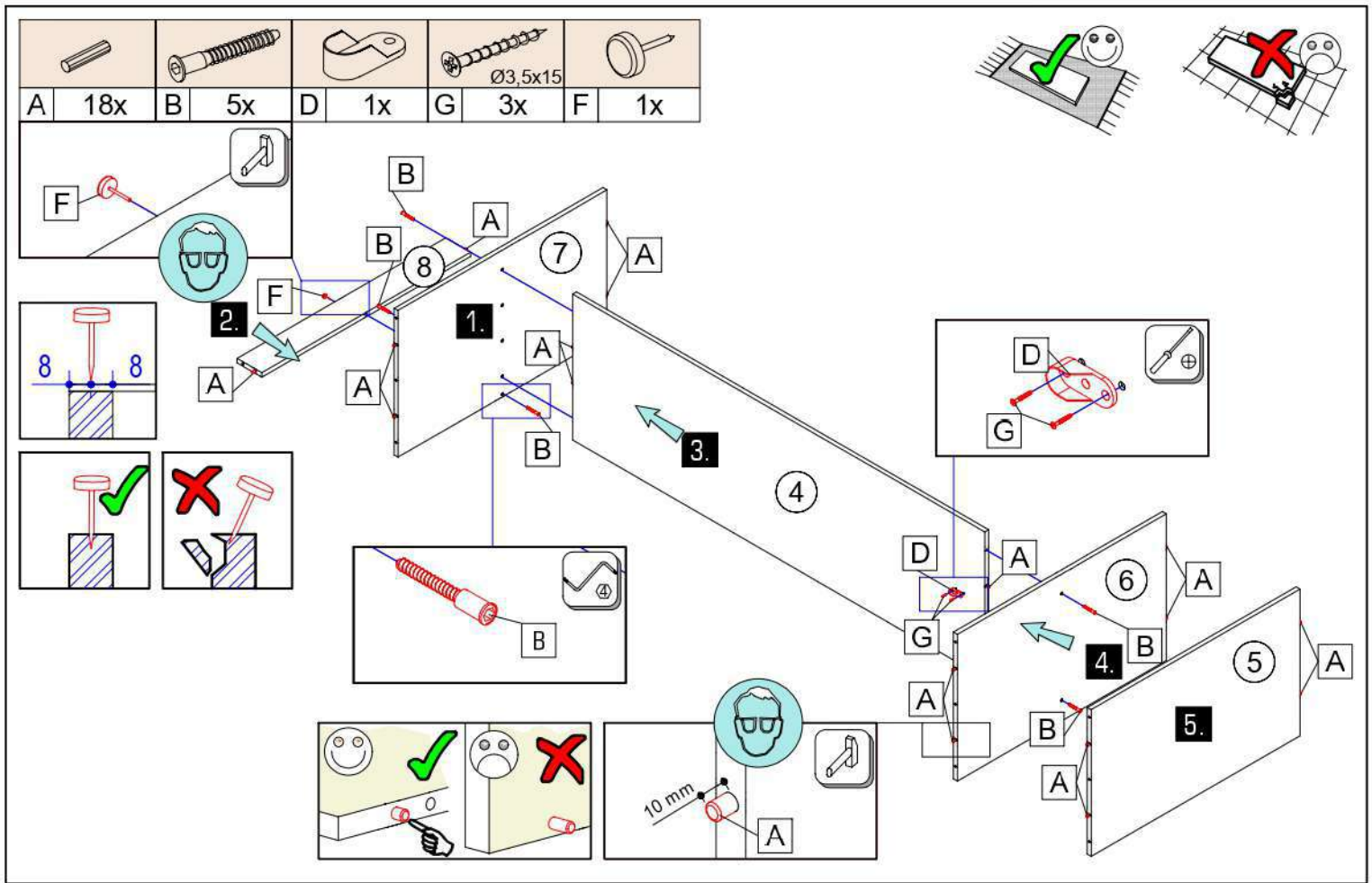

ID	ID					
03325	②	2200*550*16	1x			3/4
01359	③	2200*550*16	1x			3/4
12886	④	1712*526*16	1x	1/4		
01316	⑤	868*528*16	1x	1/4		
01361	⑥	868*528*16	1x	1/4		
01362	⑦	868*528*16	1x	1/4		
01318	⑧	103*868*16	1x	1/4		
01319	⑨	868*120*16	1x	1/4		
01363	⑩	425*518*16	4x	1/4		
01320	⑪	2093*442*2,5	2x			3/4
12887	⑫	2092*446*16	1x		2/4	
12888	⑬	2092*446*16	1x		2/4	

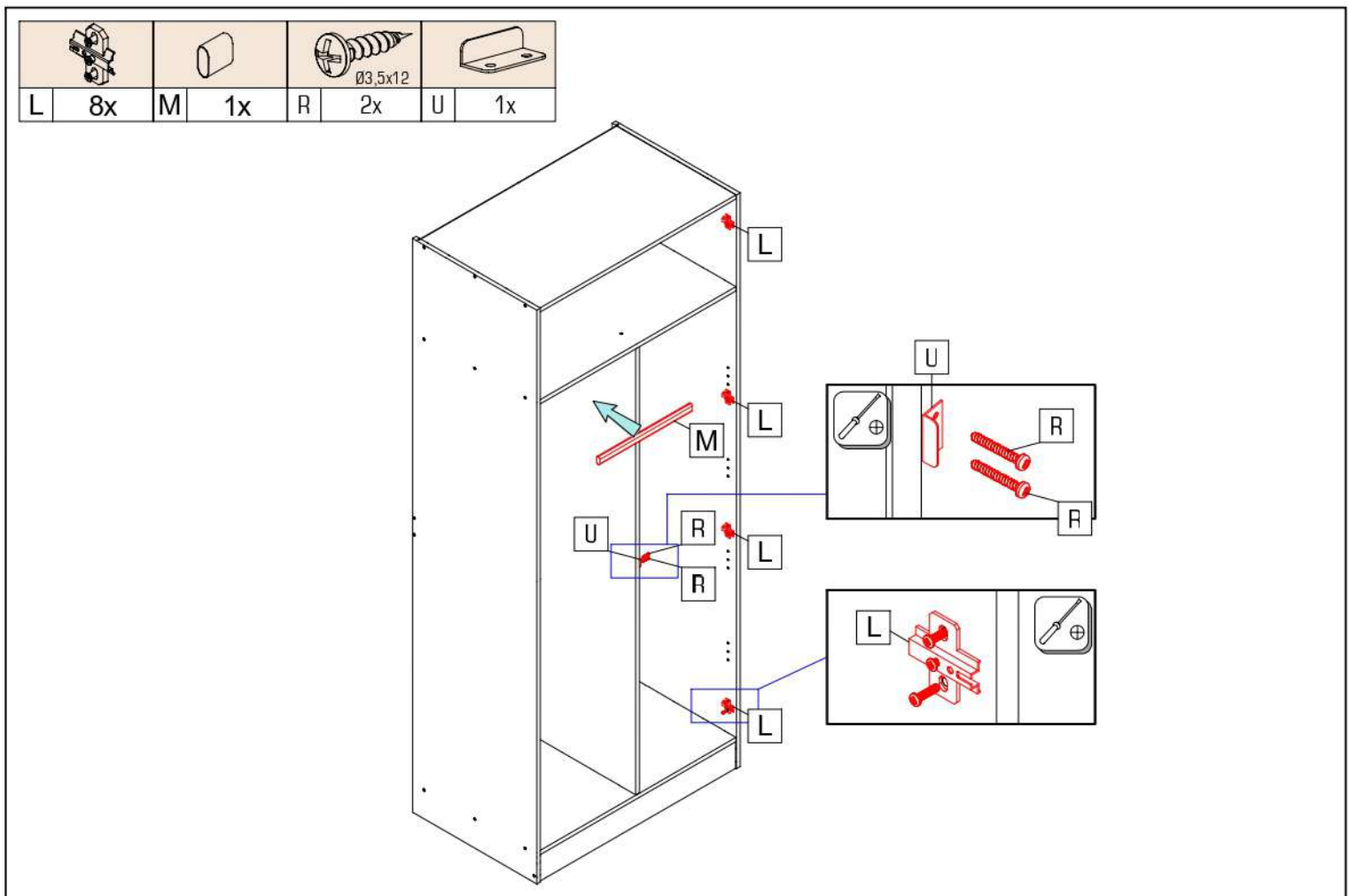
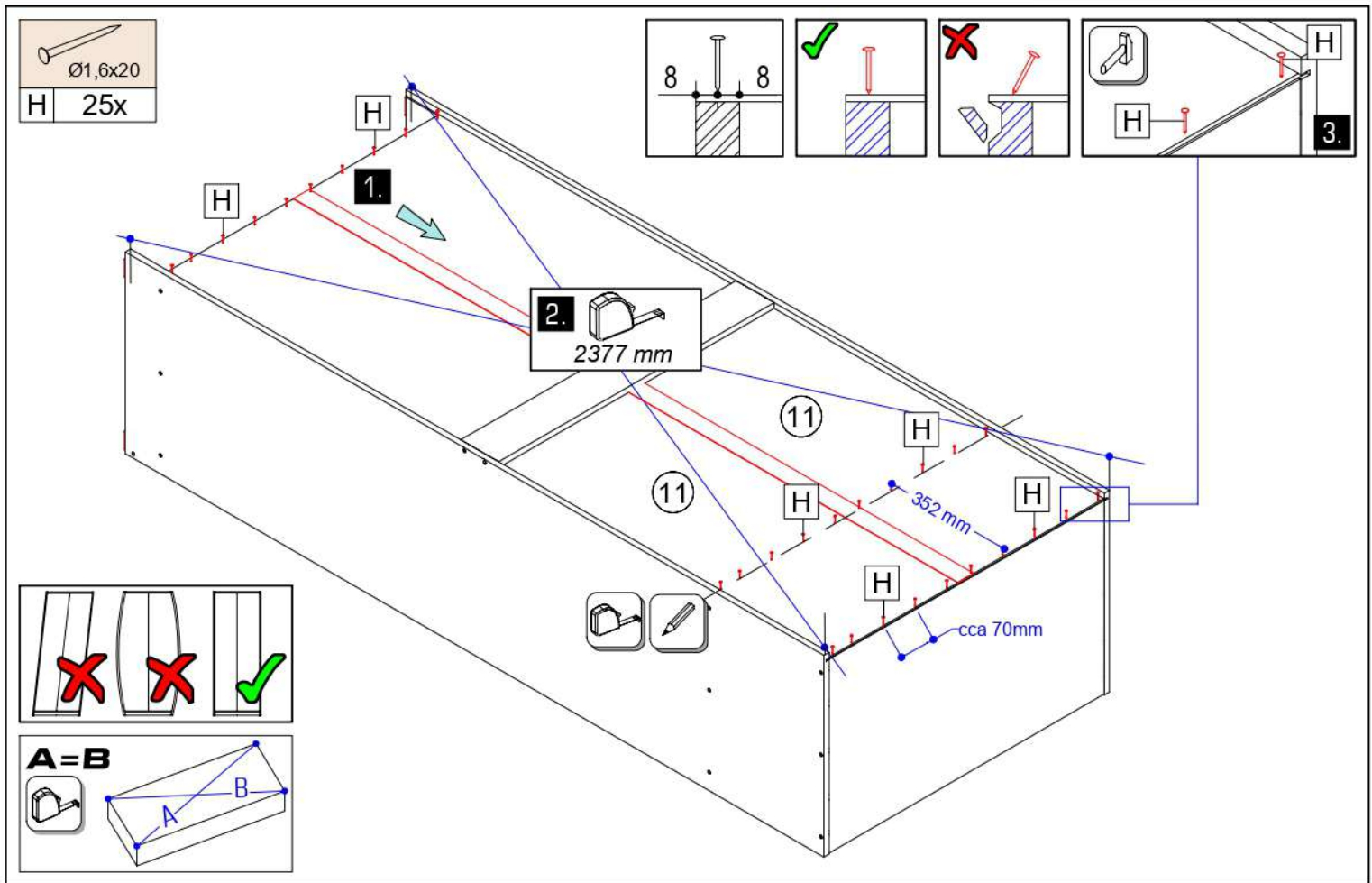







						
E 1x	G 16x Ø3,5x15	J 2x	K 8x	N 1x	S 4x Ø3,0x20	T 4x

